

TOSHIBA BIPOLAR LINEAR INTEGRATED CIRCUIT SILICON MONOLITHIC

TA8238K**7.3W×2CH AUDIO POWER IC**

The TA8238K is dual audio power amplifier for consumer application.

It contains various kind of protectors and the function of stand-by switch.

FEATURES

- Output Power
 - : $P_{OUT(1)} = 7.3W$ (Typ.)
($V_{CC} = 13.2V$, $f = 1kHz$, $THD = 10\%$, $R_L = 2\Omega$)
 - : $P_{OUT(2)} = 6.4W$ (Typ.)
($V_{CC} = 14.4V$, $f = 1kHz$, $THD = 10\%$, $R_L = 4\Omega$)
 - : $P_{OUT(3)} = 5.3W$ (Typ.)
($V_{CC} = 13.2V$, $f = 1kHz$, $THD = 10\%$, $R_L = 4\Omega$)
- Total Harmonic Distortion
 - : $THD = 0.1\%$ (Typ.)
($V_{CC} = 13.2V$, $f = 1kHz$, $P_{out} = 1W$, $R_L = 4\Omega$)
- Built In Stand-By Switch Function
 - : $I_{STBY} = 1\mu A$ (Typ.)
(With Pin⑨ set at High, power is turned ON.)
- Built In Junction Temperature Detection Function
(Pin① : $10mV/^\circ C$)
- Built In Various Protection Circuits
 - : Over Voltage, Thermal Shut Down
Out to GND, Out to V_{CC}
- Operating Supply Voltage
 - : $V_{CC(opr.)} = 6\sim 18V$

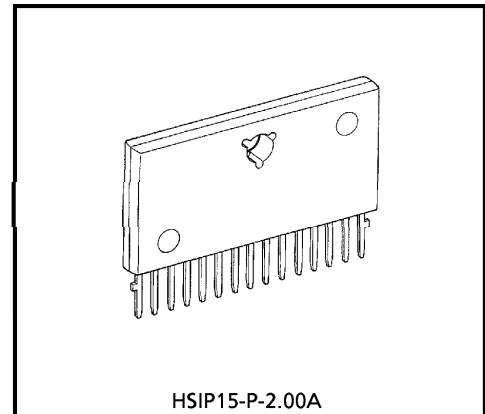

Weight : 3.9g (Typ.)

980508EBA2

- TOSHIBA is continually working to improve the quality and the reliability of its products. Nevertheless, semiconductor devices in general can malfunction or fail due to their inherent electrical sensitivity and vulnerability to physical stress. It is the responsibility of the buyer, when utilizing TOSHIBA products, to observe standards of safety, and to avoid situations in which a malfunction or failure of a TOSHIBA product could cause loss of human life, bodily injury or damage to property. In developing your designs, please ensure that TOSHIBA products are used within specified operating ranges as set forth in the most recent products specifications. Also, please keep in mind the precautions and conditions set forth in the TOSHIBA Semiconductor Reliability Handbook.
- The products described in this document are subject to foreign exchange and foreign trade laws.
- The information contained herein is presented only as a guide for the applications of our products. No responsibility is assumed by TOSHIBA CORPORATION for any infringements of intellectual property or other rights of the third parties which may result from its use. No license is granted by implication or otherwise under any intellectual property or other rights of TOSHIBA CORPORATION or others.
- The information contained herein is subject to change without notice.

BLOCK DIAGRAM

($G_V = 52\text{dB}$)

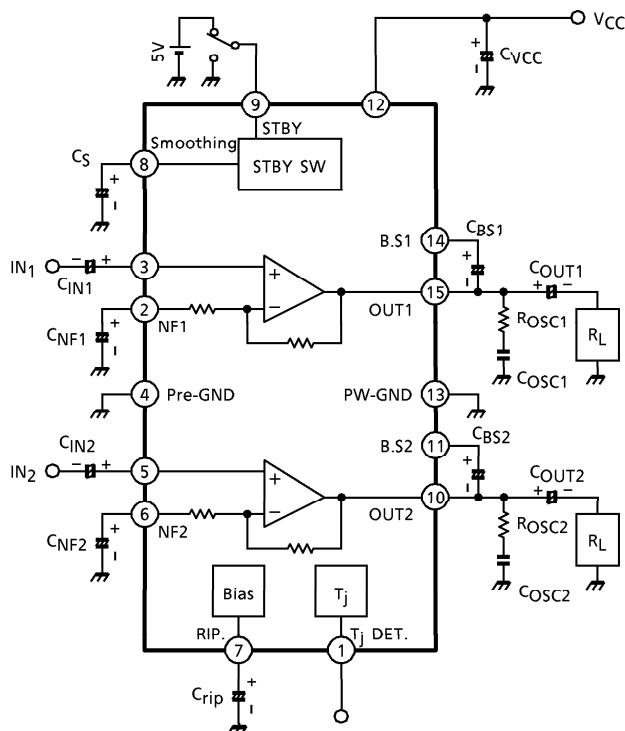

CAUTION AND APPLICATION METHOD

(Description is made only on the single channel.)

1. Voltage Gain Adjustment

The closed loop voltage gain (G_V) is determined by R_1 , R_2 and R_f .

$$G_V = 20 \log \frac{R_f + R_1 + R_2}{R_f + R_1} \text{ (dB)}$$

When $R_f = 0$, $G_V = 52\text{dB}$ (Typ.) is given.

The voltage gain is reduced when R_f is increased.

(Fig.2)

With the voltage gain reduced, since the oscillation stability is reduced, refer to the items 3.

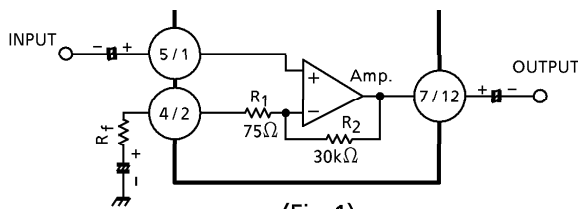

(Fig.1)

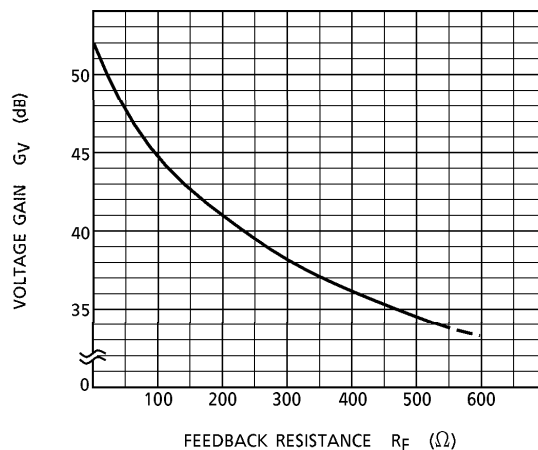

(Fig.2)

2. Stand-by SW Function

By means of controlling pin⑨ (Stand-by terminal) to High and Low, the power supply can be set to ON and OFF. The threshold voltage of pin⑨ is set at 2.1V ($3V_{BE}$), and the Power Supply current is about $1\mu A$ (Typ.) at the stand-by state.

Control Voltage pin⑨ : V (SB)

Stand-By	Power	V (SB) (V)
ON	OFF	0~2
OFF	ON	$3 \sim V_{CC}$

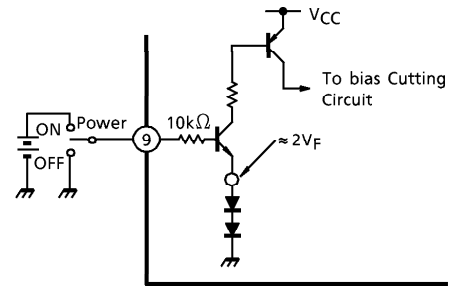

(Fig.3)With Pin⑨ Set to High, Power is Turned ON.

Advantage of Stand-by SW

- (1) Since V_{CC} can directly be controlled to ON, OFF by the microcomputer, the switching relay can be omitted.
- (2) Since the control current is microscopic, the switching relay of small current capacity is satisfactory for switching.

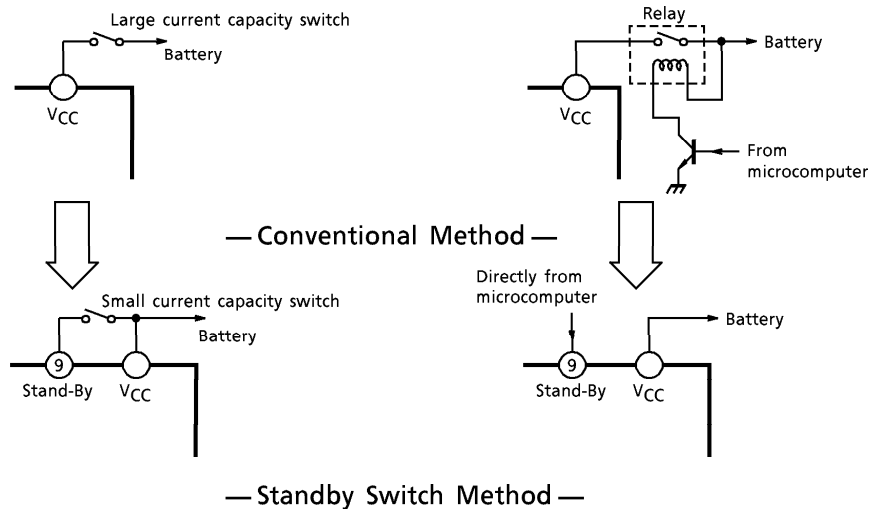

3. Preventive Measure Against Oscillation

C_{OSC} : For preventing the oscillation, it is advisable to use C_{OSC} , the condenser of polyester film having small characteristic fluctuation of the temperature and the frequency.

The resistance R to be series applied to C_{OSC} is effective for phase correction of high frequency, and improves the oscillation allowance.

- (1) Voltage gain to be used (G_V Setting)
- (2) Capacity value of condenser
- (3) Kind of condenser
- (4) Layout of printed board

In case of its use with the voltage gain G_V reduced or with the feedback amount increased, care must be taken because the phase-inversion is caused by the high frequency resulting in making the oscillation liable generated.

4. Junction Temperature Detecting pin①

Using temperature characteristic of a band gap circuit and in proportion to junction temperature, pin① DC voltage : V_2 rises at about $+10\text{mV}/^\circ\text{C}$ temperature characteristic. So, the relation between V_2 at $T_j = 25^\circ\text{C}$ and V_{2x} at $T_j = x^\circ\text{C}$ is decided by the following expression :

$$T (x^\circ\text{C}) = \frac{V_{2x} - V_2 (25^\circ\text{C})}{10\text{mV}/^\circ\text{C}} + 25 (^\circ\text{C})$$

In deciding a heat sink size, a junction temperature can be easily made clear by measuring voltage at this pin while a backside temperature of IC was so far measured using a thermocouple type thermometer.

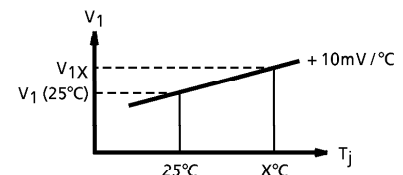

(Fig.4)

5. Pop Noise

The pop noise is reduced by the time constant τ of pin⑧ : smoothing.

Therefore, we recommend $C_5 = 100\mu\text{F}$, which is between pin⑧ and GND, because the pop noise will become worse by using the smaller capacity of C_5 .

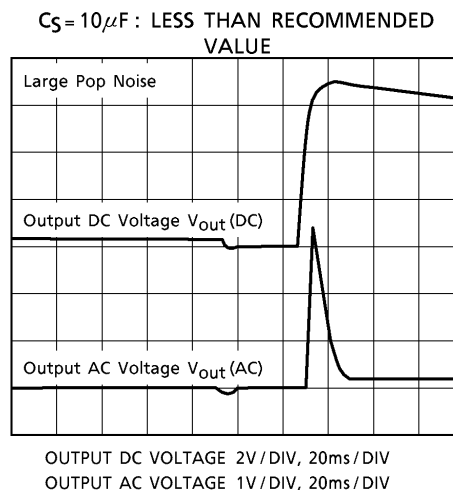
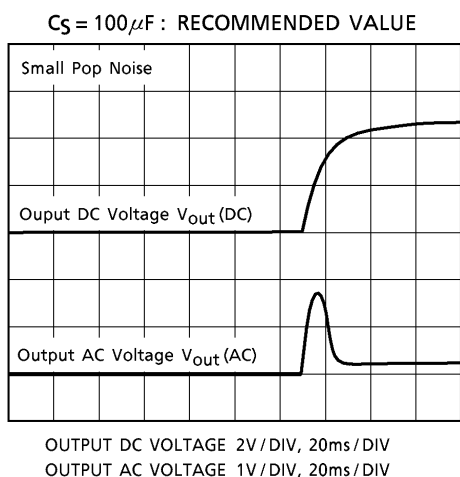

MAXIMUM RATINGS (Ta = 25°C)

CHARACTERISTIC	SYMBOL	RATING	UNIT
Peak Supply Voltage (0.2s)	$V_{CC}(\text{surge})$	50	V
DC Supply Voltage	$V_{CC}(\text{DC})$	20	V
Operating Supply Voltage	$V_{CC}(\text{opr})$	18	V
Output Current (peak)	$I_O(\text{peak})$	4.5	A
Power Dissipation	P_D	15	W
Operating Temperature	T_{opr}	- 30~85	°C
Storage Temperature	T_{stg}	- 55~150	°C

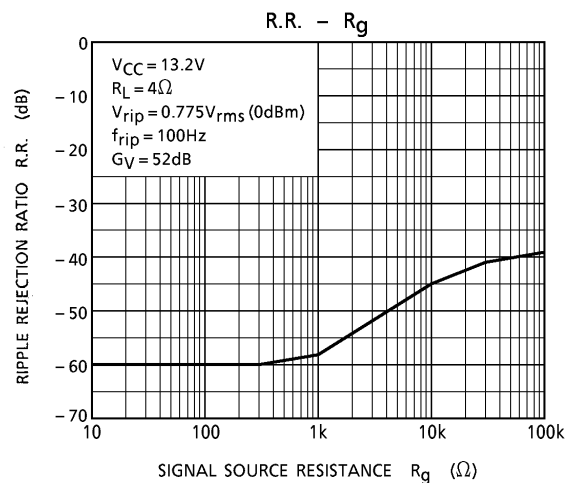
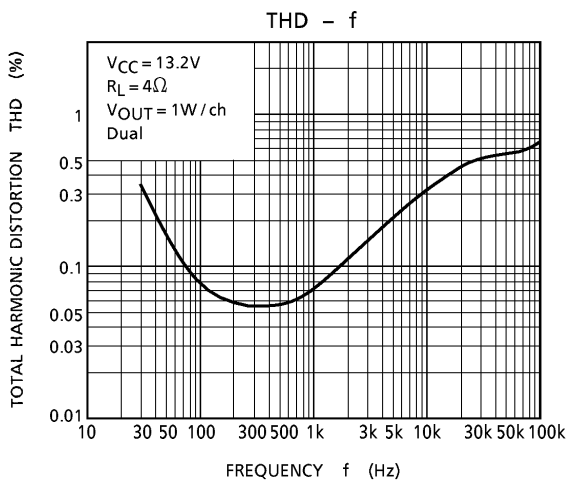
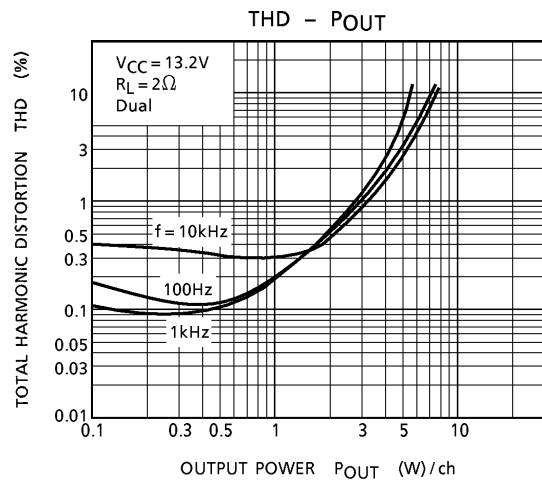
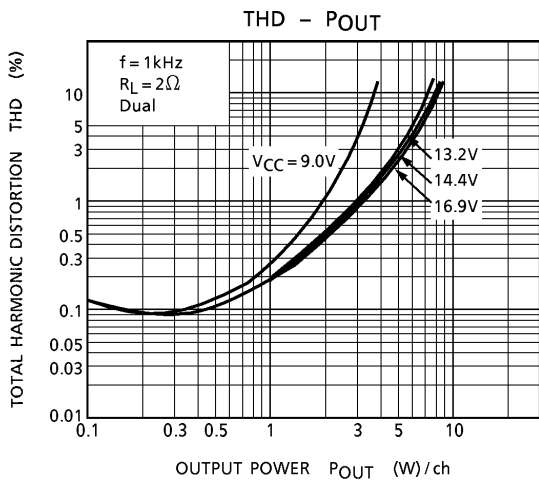
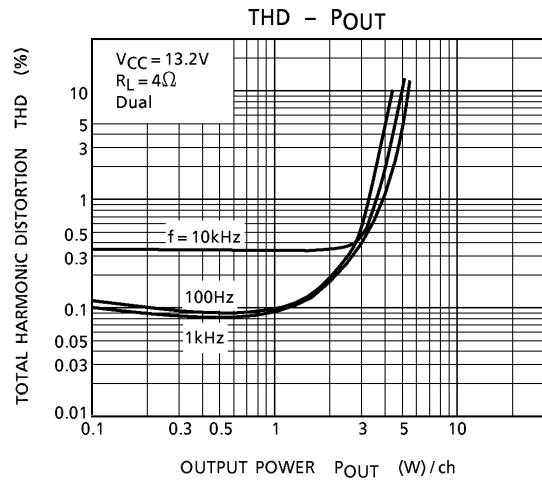
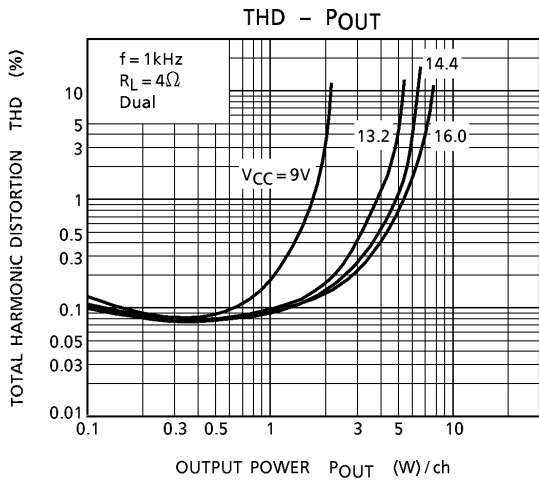

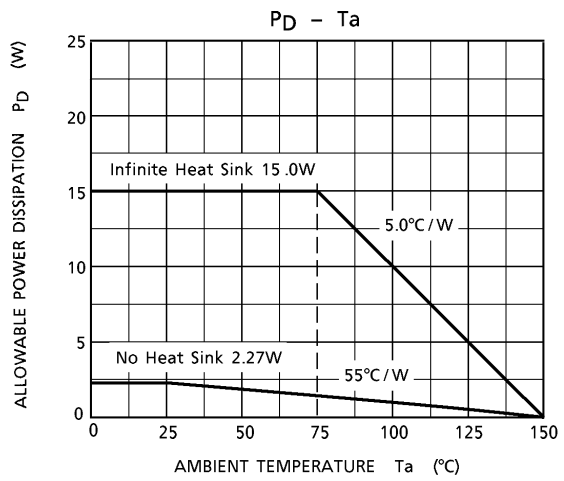
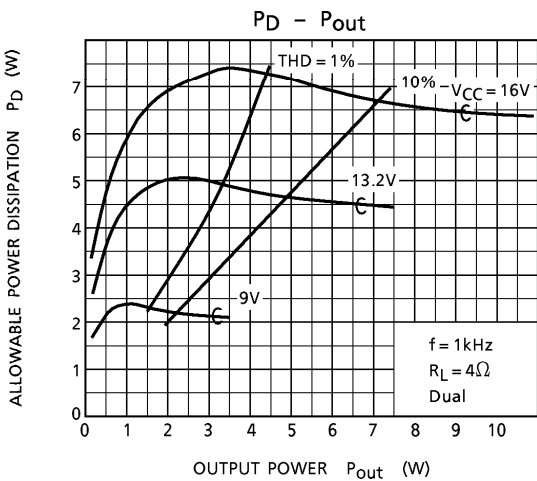
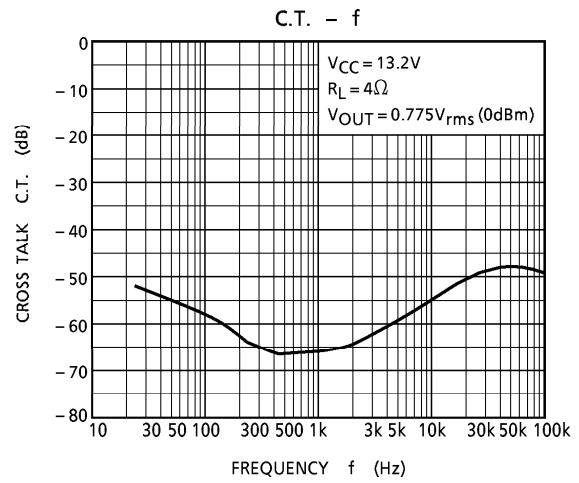
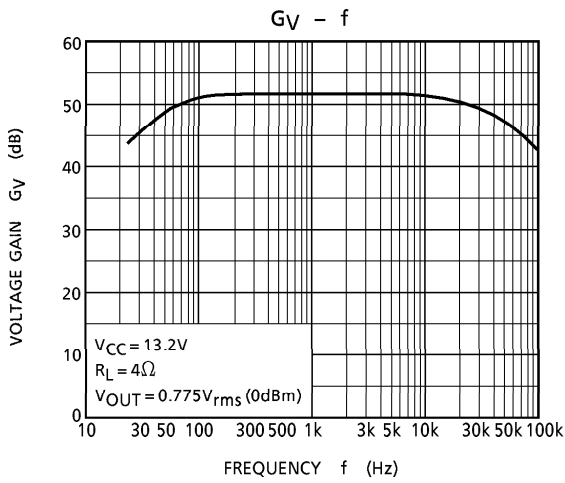
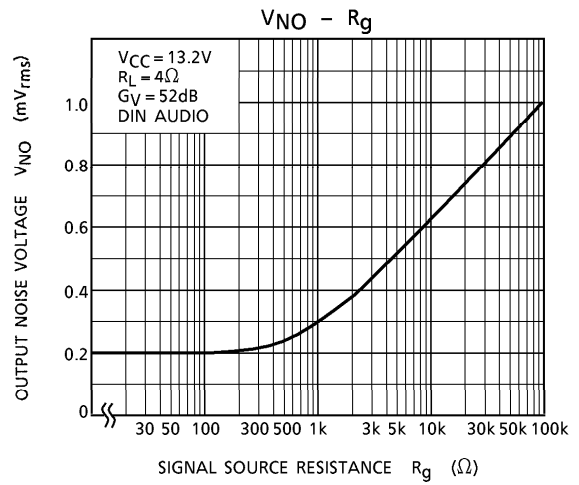
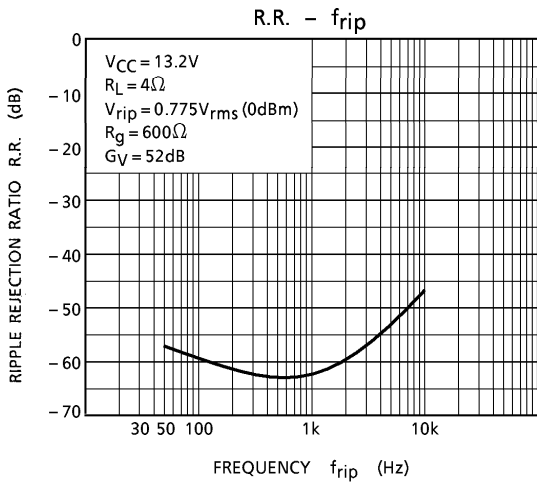

OUTLINE DRAWING
HSIP15-P-2.00A

Unit : mm

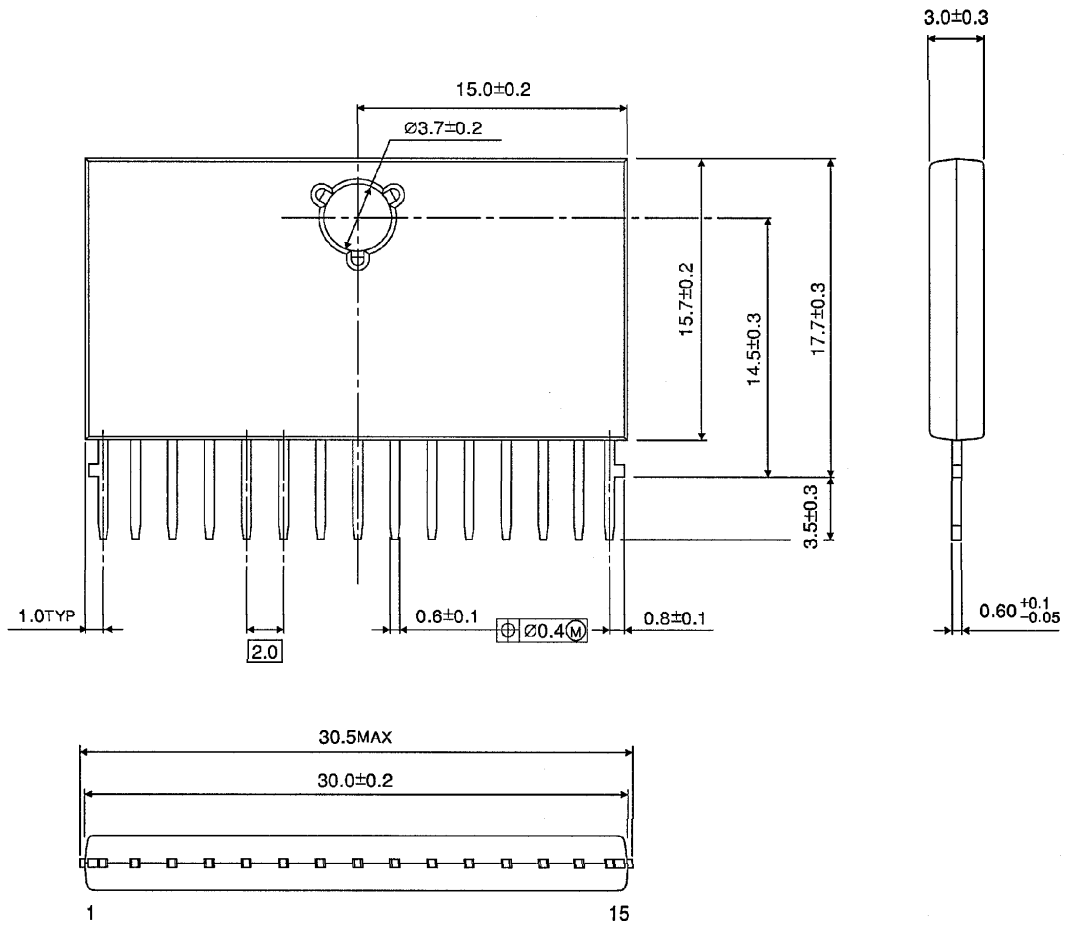

Weight : 3.9g (Typ.)