

Monolithic Linear Integrated Circuit

# LA1232 — FM IF System

## Functions

- |                           |                                   |
|---------------------------|-----------------------------------|
| 1. IF amp, limiter        | 6. Signal meter drive output      |
| 2. Quadrature detector    | 7. AFC, tuning meter drive output |
| 3. AF preamp              | 8. Delay AGC output               |
| 4. Muting at weak input   | 9. Muting drive voltage inverter  |
| 5. Muting during detuning | 10. IF amp stop circuit           |

## Features

- High limiting sensitivity: 18uV typ
- Low distortion: 0.05% typ. (Depends on the linearity of the phase characteristic of the phase shifter.)
- High demodulation output: 330mVrms typ.
- High S/N: 84.0dB typ.
- Pop noise reduced muting during detuning
- Signal meter drive output in proportion to input signal level (dB)
- Detuning muting band having good symmetry
- Tuning meter drive output having wide deflection
- Delay AGC drive output for front end
- On-chip voltage regulator: operating voltage=9 to 14V
- Excellent interstation muting characteristic
- Pin compatible with LA1231N

## General Description

The LA1232 is a high integration IC that is intended for use in FM IF systems and contains almost all the functions required for the IF stage of an FM tuner. The equivalent circuit block diagram is shown below. A sample application circuit is also shown below together with its peripheral circuit. The IF amplifier/limiter stage consists of 6 stages of double-ended differential amplifier having good AMR characteristic, and a signal meter drive stage coupled in parallel with the amplifier/limiter stage is composed of 3 stages of level detector and a drive circuit for extending the linearity range.

## Equivalent Circuit Block Diagram

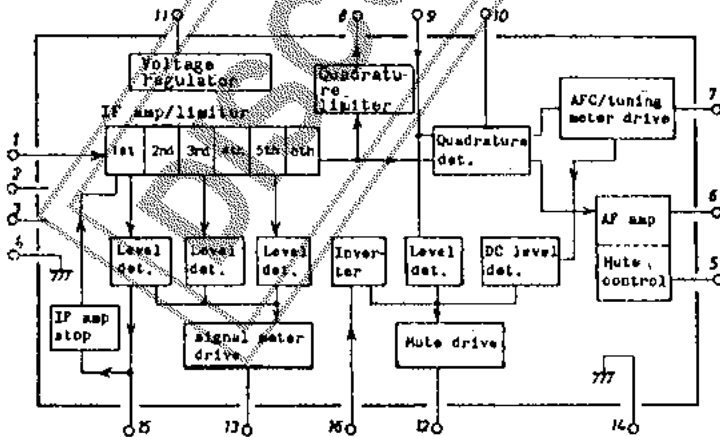

## Case Outline 3006B-D16IC (unit:mm)

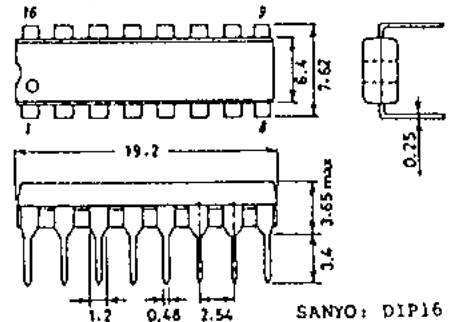

These specifications are subject to change without notice.

**SANYO Electric Co., Ltd. Semiconductor Company**

TOKYO OFFICE Tokyo Bldg., 1-10, 1 Chome, Ueno, Taito-ku, TOKYO, 110-8534 JAPAN

The FM detector stage consists of a double-balanced quadrature detector to which a low frequency preamplifier and a muting controller are attached.

The muting drive stage consists of a level detector to detect the S/N ratio of the carrier when the input signal is weak and a circuit to detect the DC output of the S curve supplied from the FM detector during detuning and a drive circuit, and operates to reduce interstation noise and pop noise caused by muting during detuning.

Further, a voltage inverter is contained so that muting can be turned ON at any input signal level. The output of the voltage inverter is connected to the muting drive output pin. Muting can be turned ON/OFF by externally applying the control voltage to the input pin of the voltage inverter. For the control voltage, the signal meter drive output is suited.

The AFC output and tuning meter drive stage are of current type. The AFC sensitivity and muting bandwidth during detuning can be adjusted by an external resistor.

The IF amplifier stop circuit, being a circuit to stop the FM IF amplifier at the AM reception mode, makes it possible to reduce pop noise caused by FM-AM reception mode switchover.

#### Maximum Ratings at Ta=25°C

				unit
Maximum Supply Voltage	V <sub>CCmax</sub>	Pin 11	16	V
Maximum Input Voltage	V <sub>I</sub>	Pin 1-2	±1	Vp-p
Maximum Current Dissipation	I <sub>CC</sub>	Pin 11	40	mA
Maximum Flow-in Current	I <sub>15</sub>	Pin 15	1	mA
	I <sub>16</sub>	Pin 16	1	mA
Maximum Flow-out Current	I <sub>10</sub>	Pin 10	2	mA
	I <sub>12</sub>	Pin 12	2	mA
	I <sub>13</sub>	Pin 13	2	mA
	I <sub>15</sub>	Pin 15	2	mA
Allowable Power Dissipation	P <sub>dmax</sub>		650	mW
Operating Temperature	T <sub>opg</sub>		-20 to +70	°C
Storage Temperature	T <sub>stg</sub>		-20 to +125	°C

#### Operating Conditions at Ta=25°C

				unit
Recommended Operating Voltage	V <sub>CC</sub>		12	V

#### Operating Characteristics at Ta=25°C, V<sub>CC</sub>=12V, f=10.7MHz

			min	typ	max	unit
Quiescent Current	I <sub>ccq</sub>	Quiescent		22	30	mA
Current Dissipation	I <sub>CC</sub>	Vin=100dBu		26.5	33	mA
Demodulation Output	V <sub>o</sub>	Vin=100dBu, 400Hz 100%mod	240	330	460	mVrms
S/N		Vin=100dBu, 400Hz 100%mod	78	84		dB
Input Limiting Voltage	Vin(Lim)	V <sub>o</sub> 3dB down, 400Hz 100%mod		25	31	dB
Total Harmonic Distortion	THD	Vin=100dBu, 400Hz 100%mod		0.05	0.3	%
Muting Sensitivity	Vin(mute)	V12=1.4V	23	29	35	dB
Muting Attenuation	Mute(att)	V5=2V, Vin=100dBu, 400Hz 100%mod	60	65		dB
Muting Bandwidth	BW(mute)	Vin=100dBu, V12=1.4V	140	220	370	kHz
AM Rejection	AMR	Vin=100dBu, FM 400Hz 100%mod AM 1kHz 30%mod	45	60		dB
Muting Drive Output	V <sub>12</sub>	Quiescent	4.0	4.9	6.0	V
		Vin=100dBu	0	0	0.3	V
Signal Meter Drive Output	V <sub>13</sub>	Quiescent	0	0	0.1	V
		Vin=70dBu	1.9	3.0	4.2	V
		Vin=100dBu	4.5	5.5		V

LA1232

			min	typ	max	unit
AGC Output	V <sub>15</sub>	Quiescent	4.2	5.0	5.5	V
		V <sub>in</sub> =100dBu	0	0	0.5	V
IF OFF Current	I <sub>15</sub> (off)	Quiescent, V <sub>8-10</sub> ≤ 20mV	10	35	60	uA
Muting Operation Level Voltage	V <sub>16</sub> (mute)	V <sub>in</sub> =100dBu, V <sub>12</sub> =1.4V	0.7	0.84	1.0	V
Offset Voltage	V <sub>6-10 B</sub>	Quiescent, Pin6-10	-0.5	0	+0.5	V
	V <sub>7-10 B</sub>	Quiescent, Pin7-10, R <sub>7-10</sub> =5.1kohm	-0.25	0	+0.25	V
Pin Voltage	V <sub>1</sub>	Quiescent		2.6		V
	V <sub>2</sub>	Quiescent		2.6		V
	V <sub>3</sub>	Quiescent		2.6		V
	V <sub>6</sub>	Quiescent		5.6		V
	V <sub>7</sub>	Quiescent		5.6		V
	V <sub>8</sub>	Quiescent		5.4		V
	V <sub>10</sub>	Quiescent		5.6		V
	V <sub>12</sub>	Quiescent		4.9		V
	V <sub>13</sub>	Quiescent		0		V
	V <sub>15</sub>	Quiescent		5.0		V

Test Circuit

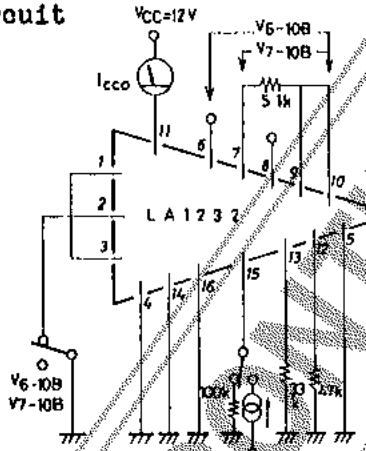

DC Characteristic Test Circuit

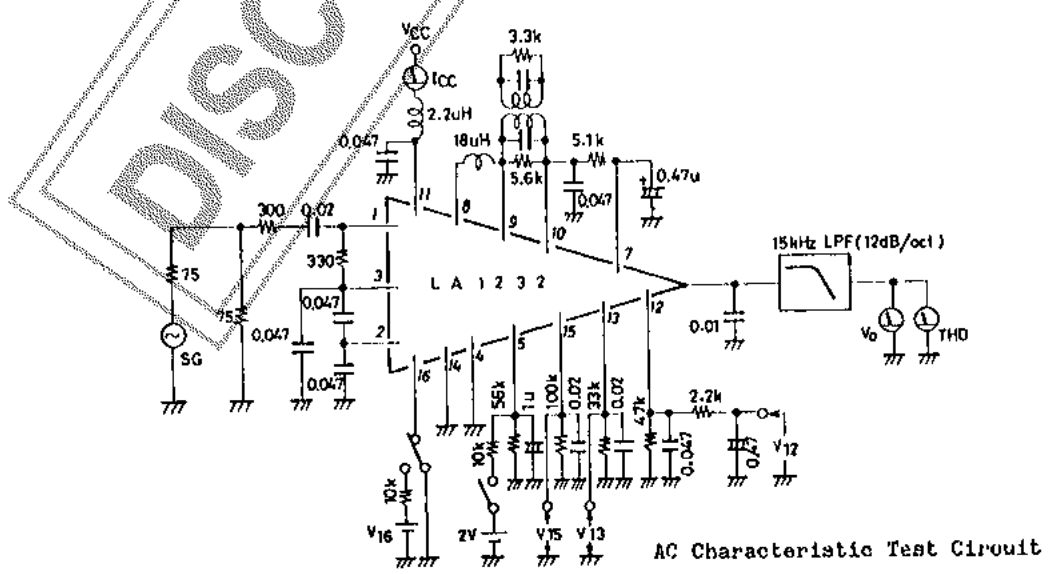
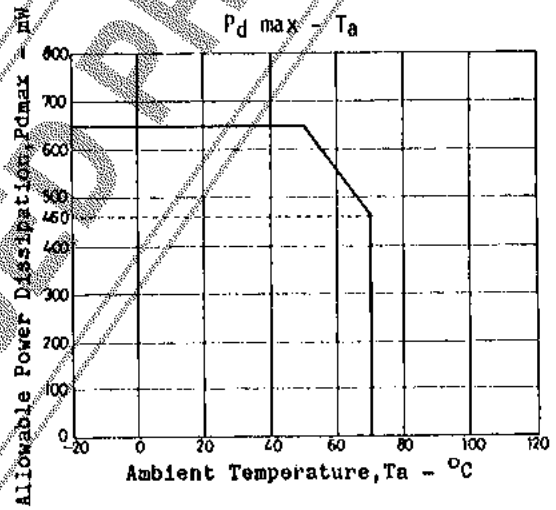

AC Characteristic Test Circuit

Sample Application Circuit

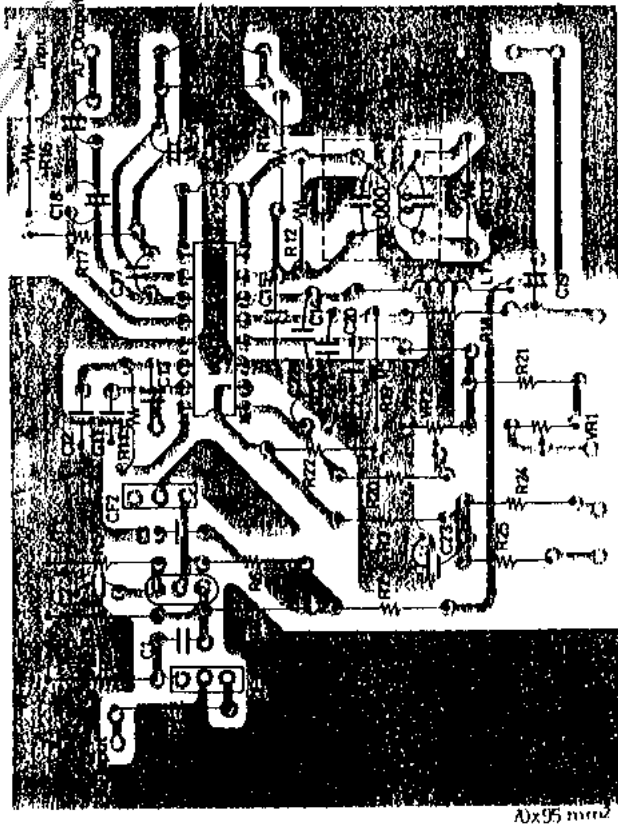
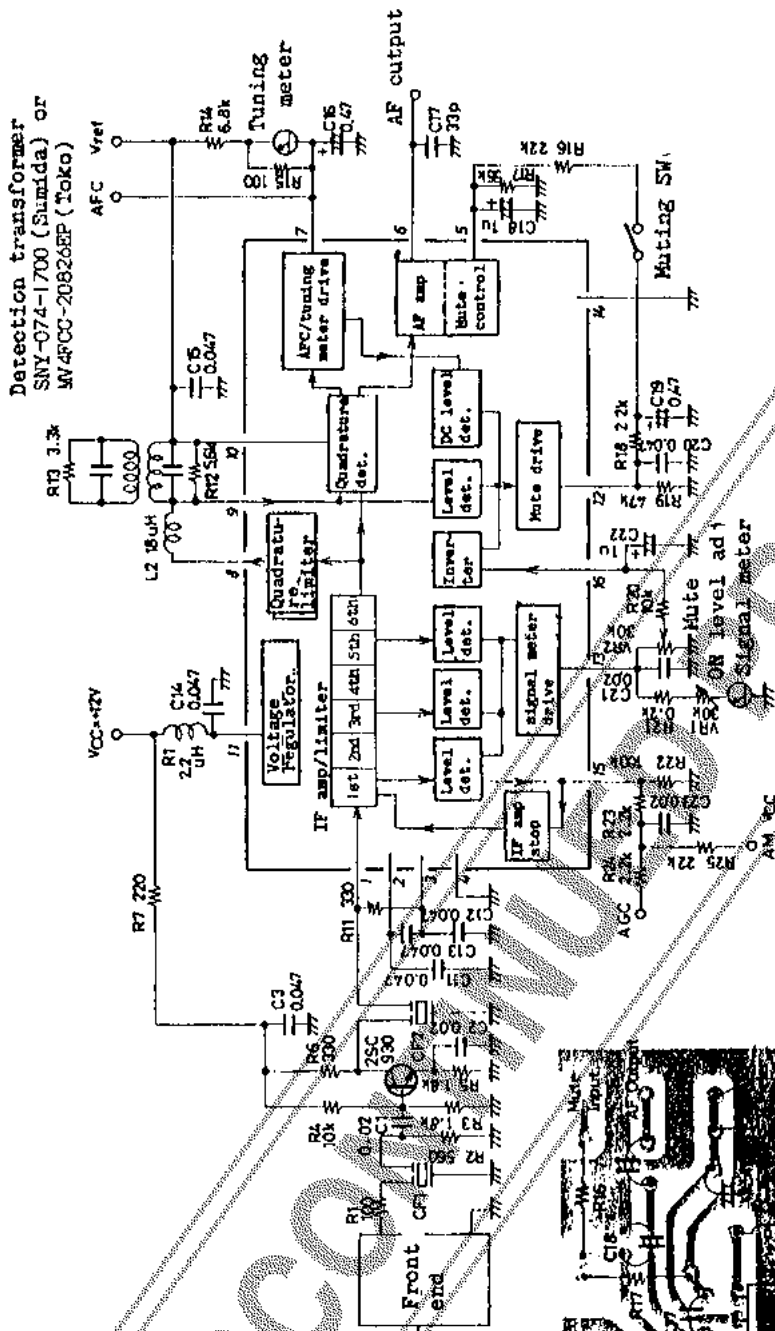

Sample Printed Circuit Pattern (70x95mm<sup>2</sup>, Cu-folled area)

10x95mm

Demodulation Output  $V_0$ , Distortion THD,  
 AM Rejection AMR, Output Noise Voltage  $V_{NO}$

Input Characteristics

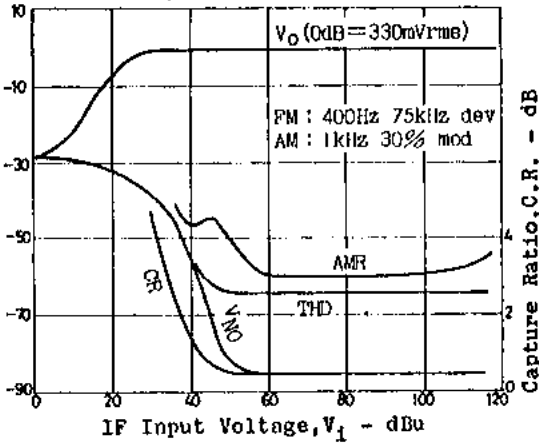

pin Voltage -  $v_i$

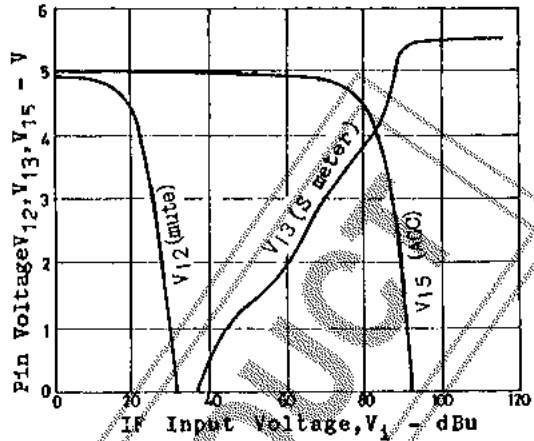

pin Voltage -  $\Delta f$

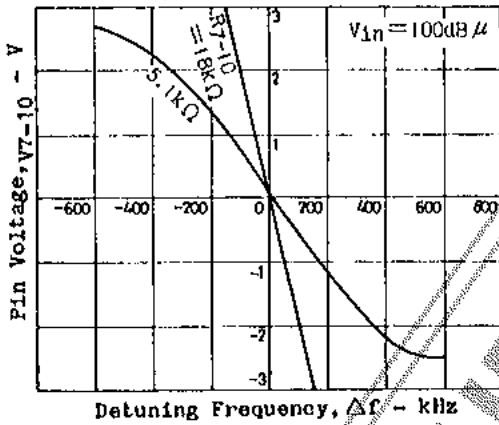

pin Voltage -  $\Delta f$

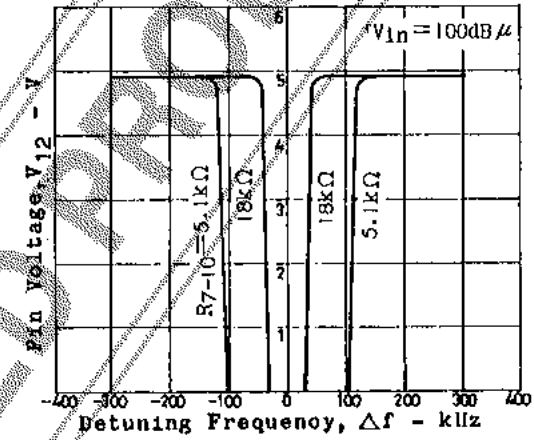

Muting Attenuation -  $V_5$

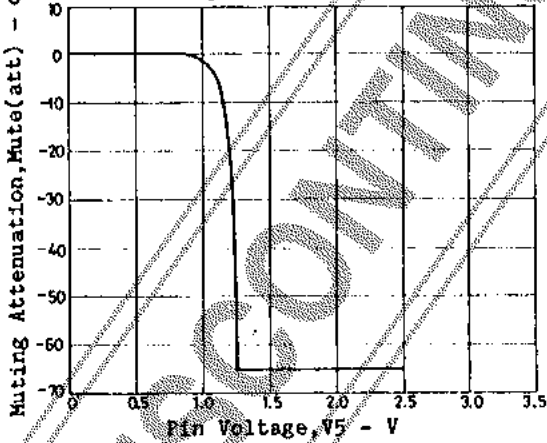

$V_{12} - V_9$

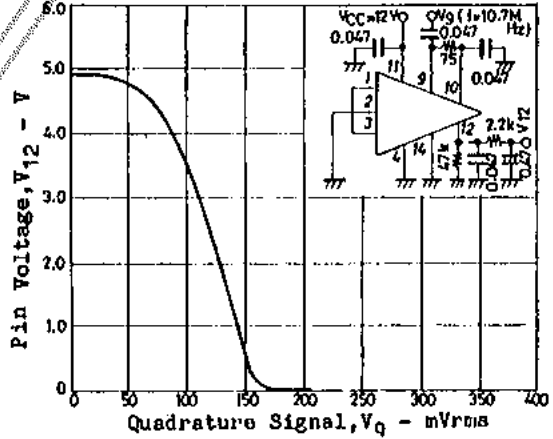

$V_{12} - V_{16}$

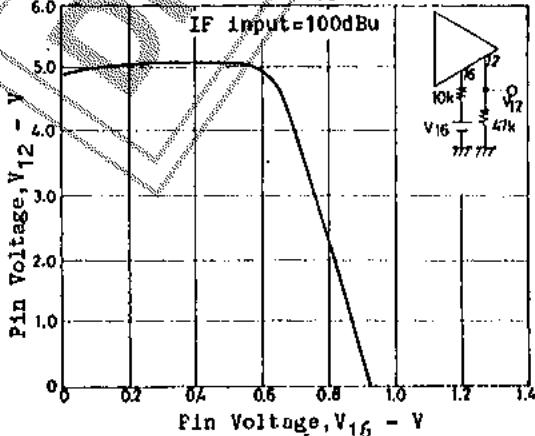

$V_{12} - V_{16-G}$

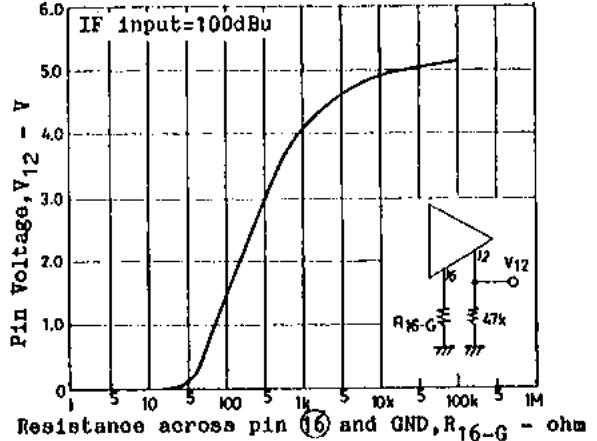

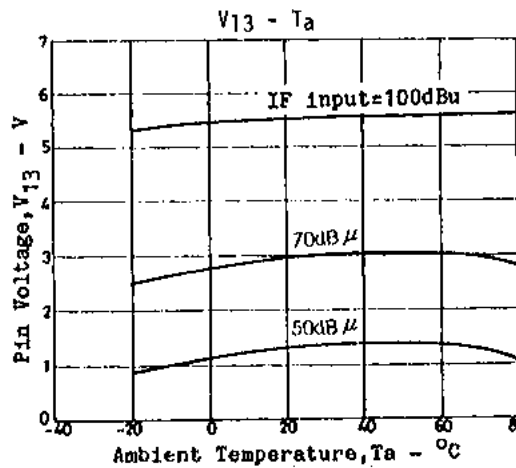
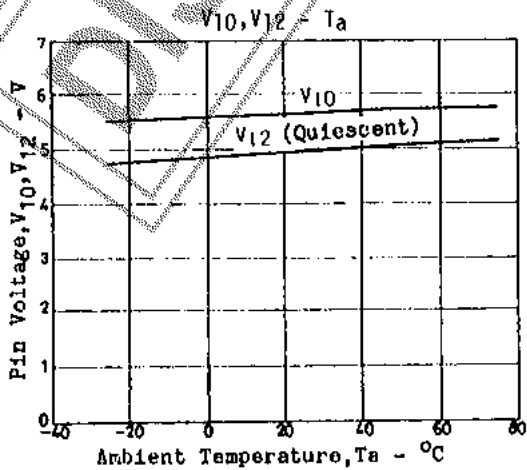
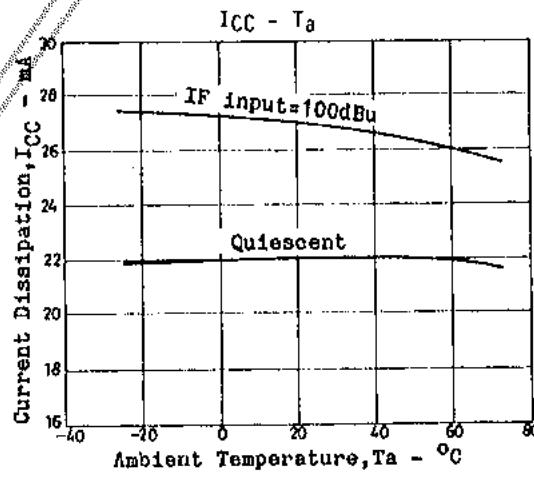
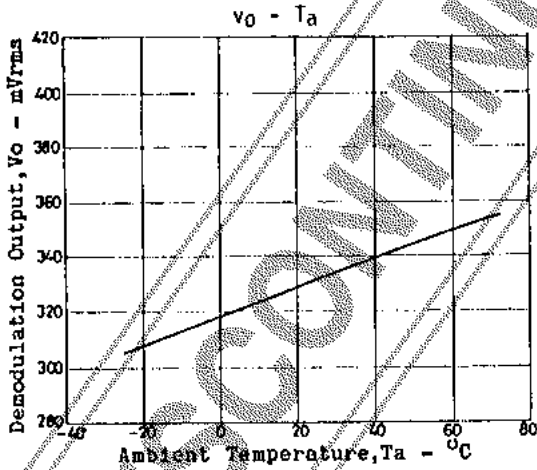
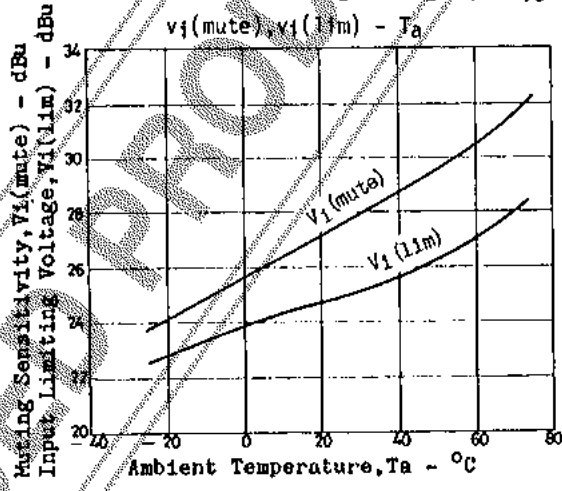
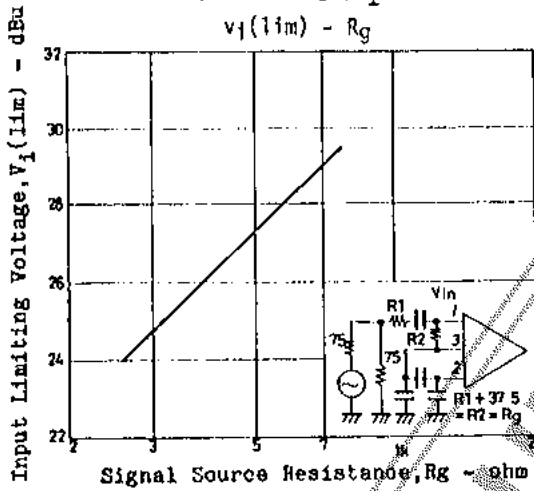
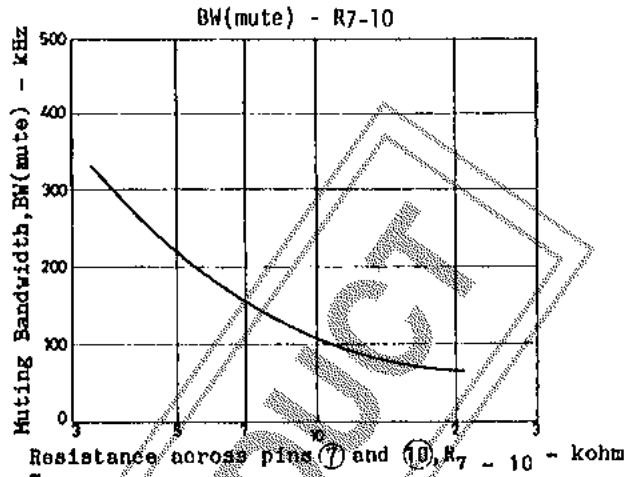
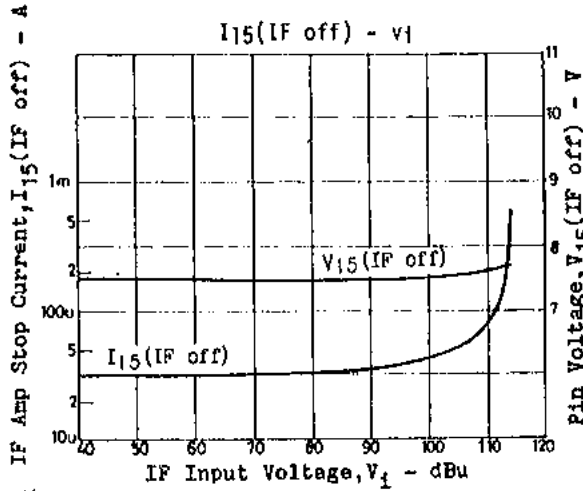

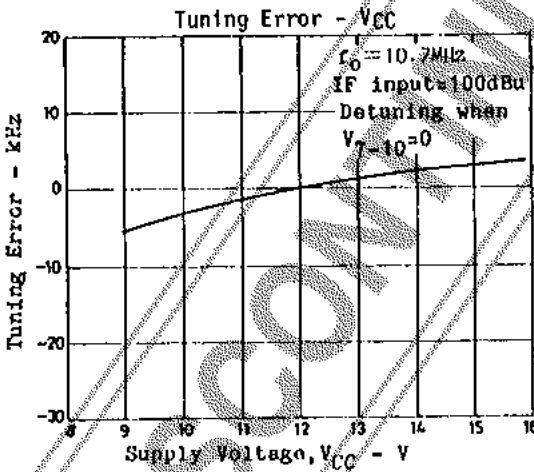
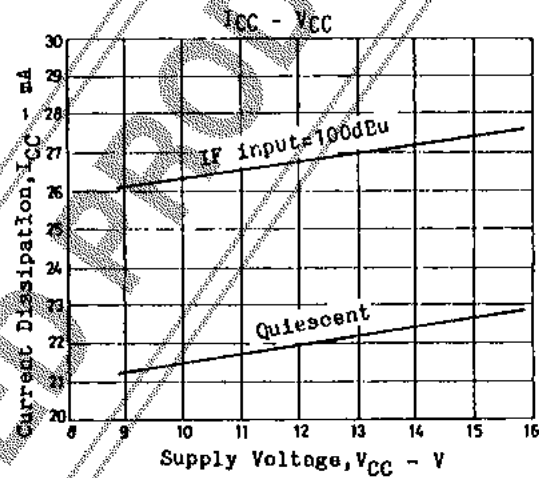
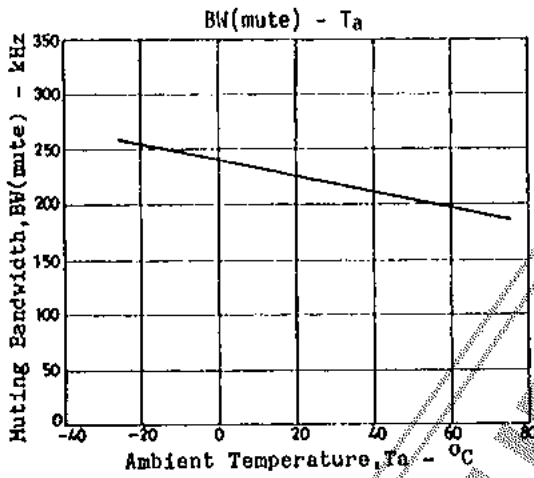
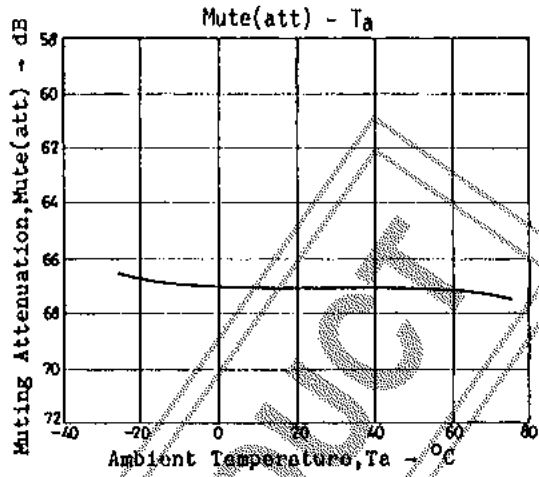
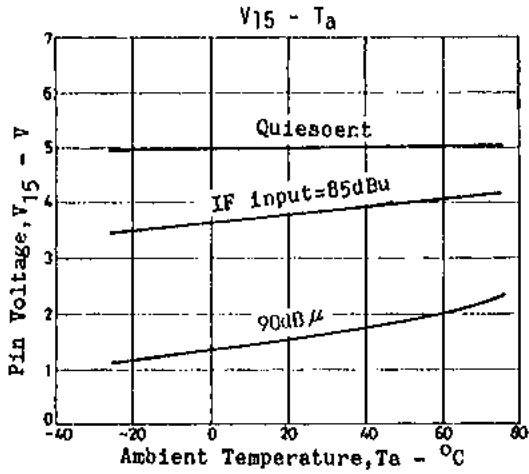

Information furnished by SANYO is believed to be accurate and reliable. However, no responsibility is assumed by SANYO for its use; nor for any infringements of patents or other rights of third parties which may result from its use, and no license is granted by implication or otherwise under any patent or patent rights of SANYO.